

# Selection Guide





We make what matters work.\*



At Eaton, we believe that power is a fundamental part of just about everything people do. That's why we're dedicated to helping our customers find new ways to manage electrical, hydraulic and mechanical power more efficiently, safely and sustainably. To improve people's lives, the communities where we live and work, and the planet our future generations depend upon. Because this is what really matters. And we're here to make sure it works.

To learn more go to: [Eaton.com/whatmatters](https://www.eaton.com/whatmatters)

**EATON**

*Powering Business Worldwide*

We make what matters work.

# Table of Contents

Description	Page Ref.
<b>Selection Guide</b> .....	1
<b>We make what matters work</b> .....	2
<b>Small, hyper scale or in between, we bring innovation to your data center</b> .....	4
<b>Rack Configuration Guide</b> .....	5
<b>RA Series Rack - multiple level application solutions</b> .....	6
<b>Rack Horizontal Cable and Air Management</b> .....	9
<b>Rack Shelving</b> .....	14
<b>External Rack Upgrades</b> .....	17
<b>Hardware &amp; Accessories</b> .....	18

# Small, hyper scale or in between, we bring innovation to your data center

Every day the world becomes increasingly reliant on big data. Whether it's connecting regional data centers, supporting vast transactional networks, or providing services to multiple clients, you can benefit from a partner who understands the demands and nuances of your specific IT environment. Regardless of the size of the environment, Eaton delivers the thought leadership and innovation to create IT systems with exceptional reliability and agility that are tailored to your unique needs.



## Small Business

IT must provide application availability and support cloud-based architecture, virtualization, consolidation and emerging technologies. Eaton has a variety of products and services to help you keep your IT systems running efficiently without interruption.

---

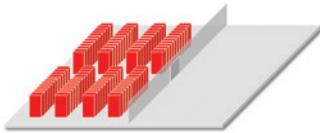

## Medium / Large Enterprise

With zero tolerance for risk, IT managers demand reliability and assurance of redundant systems. Data centers must continuously stay in step with the latest technologies and aligned with business strategies. Regardless of your data center's lifecycle – from design/build, commissioning, operation or expansion/contraction through decommissioning – you can get the most out of your existing data center with the least risk and cost.

---

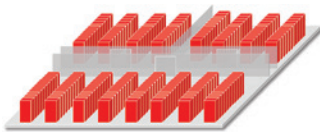

## Multi-tenant / Colocation

Faced with the challenge of having to accommodate different business models and solve for unpredictable power and cooling needs, uninterrupted service is everything. Avoiding downtime is critical. And the ability to scale up or down on demand, and faster time to market is crucial. Flexible, modular solutions with state-of-the-art power reliability, efficiency and control help you meet your tenants' needs and maximize your ROI.

---

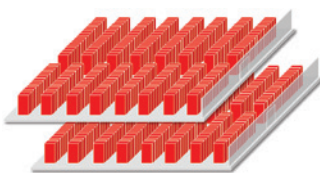

## Hyper scale

In today's environment of big data and cloud computing, exponentially increasing volumes of data and demand for different applications must be accommodated quickly and cost-effectively. Growth can't outpace capacity. High performance computing and higher density architecture call for innovative solutions from an expert partner who can help you deploy them efficiently and reliably.

# Rack Configuration Guide

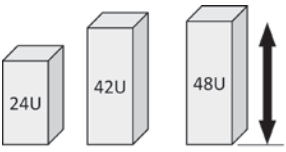
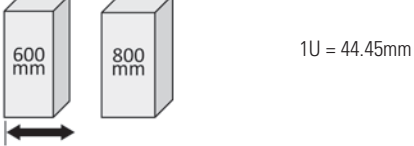
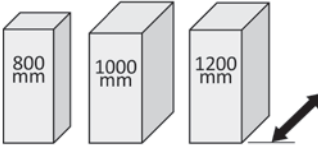
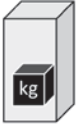
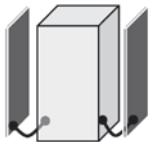
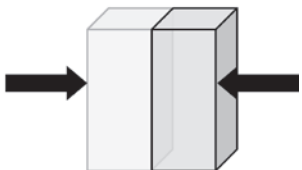
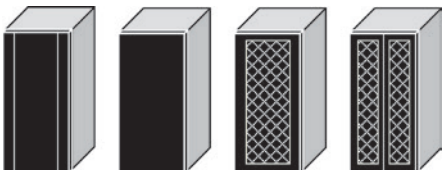
	Feature	RA Series Racks
	<b>Rack Heights</b> 24U is typically used in an office type environment. For a data closet application it makes sense to maximise the use of floor space & future proof the installation by deploying taller racks. Ensure you have sufficient clearance for the rack in the room!	24U • 42U • 48U •
	<b>Rack Widths</b> Typically 800mm wide racks are used for cabling racks (passive), racks where switches are mounted (some switches draw air across the switch to cool them) & higher density active racks where multiple Rack PDUs may be required to support the equipment.	600mm • 800mm •
	<b>Rack Depths</b> For cabling applications an 800mm deep rack is often sufficient. For mixed technologies or modern active equipment applications, racks should ideally be 1000mm deep as a minimum. 1200mm deep racks help future proof an installation providing space of active equipment & multiple supporting Rack PDUs.	800mm • 1000mm • 1200mm •
	<b>Rack Loading</b> If the rack is likely to be moved to location, loaded with equipment and left in place then you only need to consider the static load rating. If the rack is going to be moved around after the equipment is fitted then you need to consider the rack dynamic load rating (limited by the castors or wheels).	Static: 1500kg • Dynamic: 500kg •
	<b>Rack Grounding</b> Racks contain powered equipment which under fault conditions may short out on the rack structure. For safety reasons the assembly should be designed to provide earth continuity through component parts with some parts requiring the fitting of earth bonding leads. The Eaton platforms below include earth bonding / grounding kits as standard.	Rack Grounding Kit •
	<b>Rack Baying</b> Where multiple racks are positioned side by side it is good practice to bolt the racks together to ensure the racks are aligned. Bolting the racks together also helps to avoid racks tipping over when equipment is slid out of the rack. Eaton's rack platforms below have facilities to bolt the rack down to help avoid tip issues.	Rack Baying or Bolt Together Kit •
	<b>Solid Doors</b> These provide the lowest cost option & are fine for use where low levels of active equipment (<1.5kW) or passive equipment are mounted in the rack. They provide a clear view of equipment & slightly higher levels of security with higher levels of noise reduction.	Glazed Front • Plain Steel Rear
	<b>Vented Doors</b> Most active equipment designs use air to cool the internal components. Getting sufficient air into & out of the rack stops the equipment from overheating & failing. Vented doors enable racks to support higher heat loads (assumes air is conditioned in the room).	Single Vented Steel •
	<b>Double Vented Doors</b> Like the vented doors these are used to help avoid active equipment overheating. Double doors are particularly useful where the space behind an 800mm wide rack is limited (narrow aisle or tight to a wall). *Double vented doors fitted to rear of rack.	Double Vented Steel •*

# RA Series Rack - multiple level application solutions

Eaton's RA Service IT racks deliver advanced protection for critical IT equipment in network closets, small server rooms and data centre application

Designed for fast and easy set-up, the RA Series rack has features IT specialists need in an affordable ready-to-go rack system. Standard builds include load bearing castors (500kg dynamic load), jacking feet, locking front and rear doors, locking side panels, U-markings front and rear, 2 x 100mm cable trays in rear, 2 brush cable access points at top, baying kit and earth kit.

## Standard racks include;

- Fully assembled rack frame with load bearing castors and jacking feet.
- Four painted adjustable 19" mounting rails with unit height markings on front & rear.
- Enhanced cable trays facilitating PDU mounting fitted at rear.
- Top panel with 2 brush entries at rear.
- Perforated steel or glass front door.
- Split rear doors (on 800mm wide vented models) or single rear door (on 600mm wide models & solid steel rear door models).
- Swing handles with key lock front and rear.
- Locking side panels.
- Bolt-together / baying kit.
- Grounding kit.
- 2 year standard warranty.

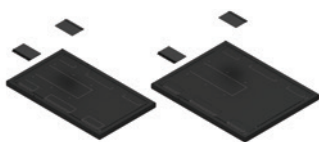
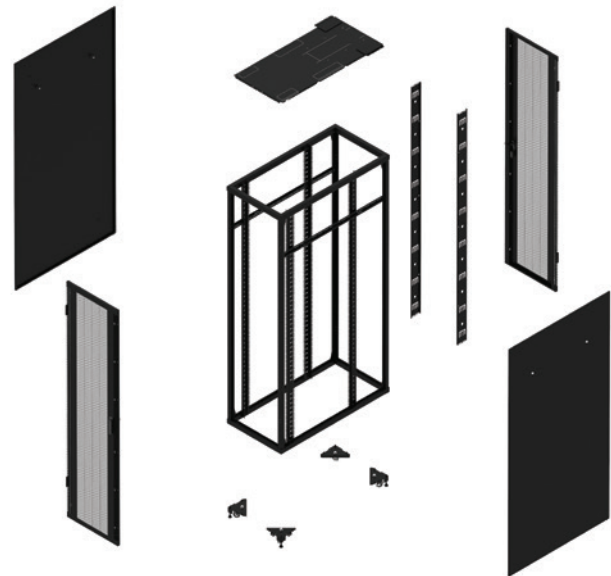

Configured top panel with 2 brush entries at rear.



HD Castors and Jacking Feet



Secure key-locking swing handles on front & rear doors.



Key locking removable side panels for security with in-set locks enabling baying together.



Cable / RackPDU / accessory tray.



Configurable lift off hinges allows field switching of door handing.

# RA Series Rack - multiple level application solutions

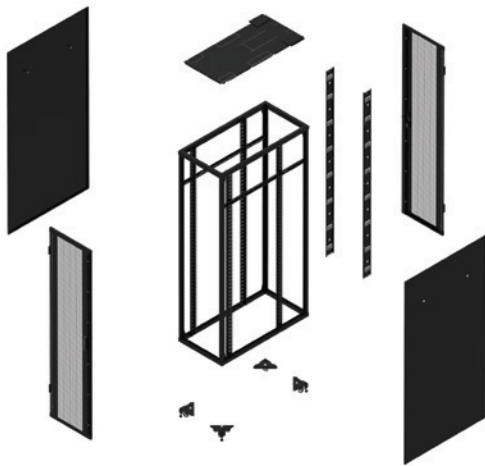

Typical 600mm wide RA Series Active Rack Configuration

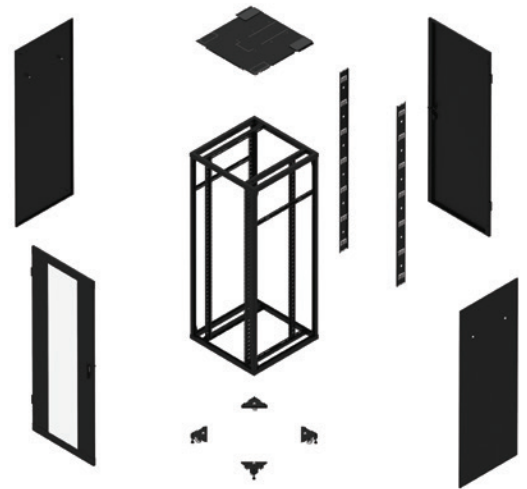

Typical 800mm wide RA Series Basic Rack Configuration

## Base detail (based on 600 wide 1200 deep) Front

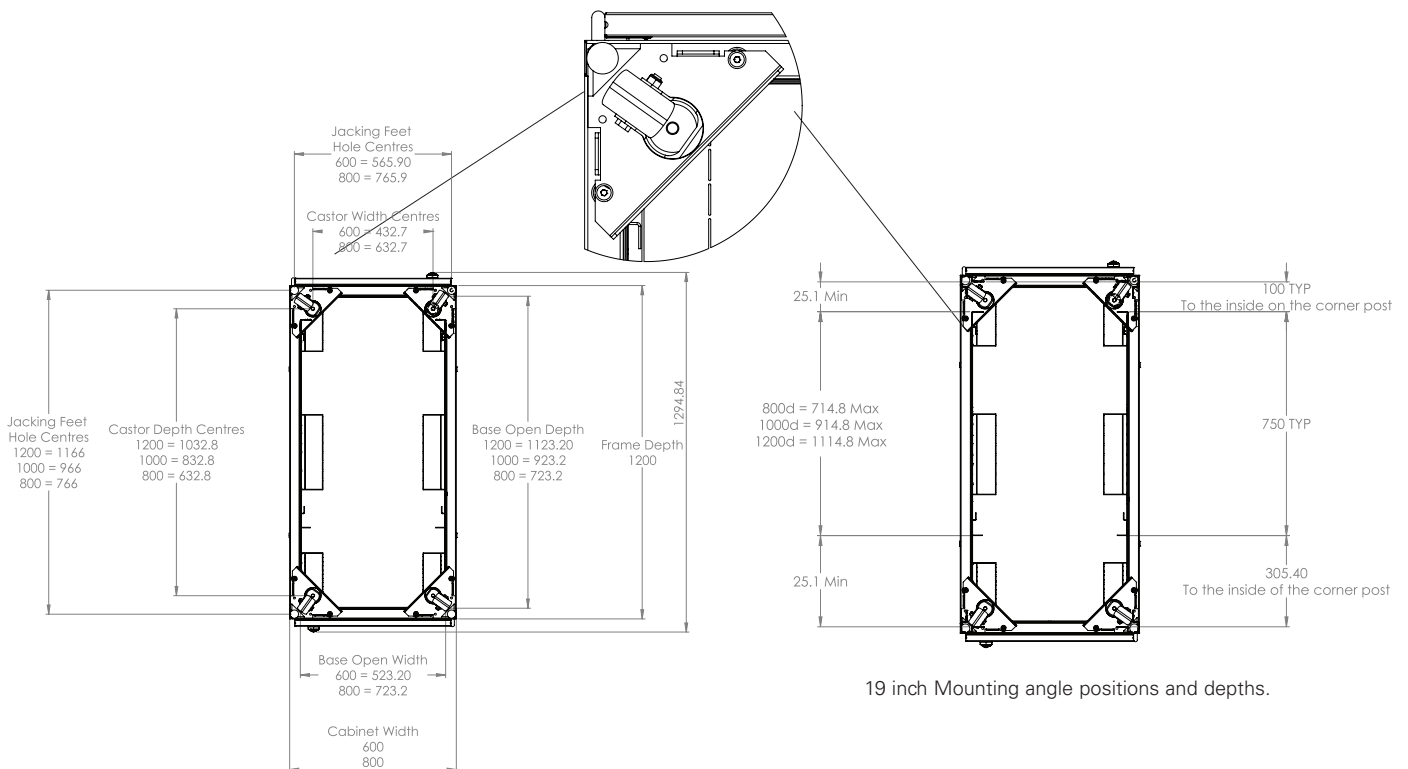

### Applicable to all in this range.

Rail Mounting Width	482.6mm (19") fully compliant to EIA-310-E
Static Load rating on jacking feet	1500kg evenly distributed
Dynamic Load rating on castors	500kg evenly distributed*
Colour	Black RAL 9005
Door opening angle	180° angle with non-bayed installations, left-hand hinged, field reversible. (160° for bayed racks)
Door perforation (vented door models);	67%
Glass specification (glass door models);	4mm clear toughened, conforms to EN12150-1
Regulatory approvals & standards	EIA-310-E, IEC / EN 60950, IEC / EN 60297-3-1:-2008, IEC529
Protection class	IP20 - when configured with doors and side panels
Warranty	2 years

\*500kg dynamic load rating is the total rolling weight of the rack including the installed equipment and is subject to the equipment load being evenly distributed at 20U height and below. Dynamic load relates to the movement of a rack within the same data centre on a smooth and level hard floor surface which is clear of any obstacles. Not suitable for transportation on a vehicle when loaded to this weight.

# RA Series Rack - multiple level application solutions

## Eaton RA Series IT Rack Technical specifications & Order codes

Equipment mounting height	24U	24U	24U	24U	24U	24U	42U
Width & Depth (mm)	<b>600W x 800D</b>	<b>600W x 800D</b>	<b>600W x 1000D</b>	<b>800W x 800D</b>	<b>800W x 800D</b>	<b>800W x 1000D</b>	<b>600W x 800D</b>
Order Code (Black finish)	RAA24608PSB13U	RAB24608PSB13U	RAA24610PSB13U	RAA24808PSB13U	RAB24808PSB13U	RAA24810PSB13U	RAA42608PSB13U
<b>Physical</b>							
Height (castors fitted as standard)	1293 mm	1293 mm	1293 mm	1293 mm	1293 mm	1293 mm	2093 mm
Height (castors removed)	1267 mm	1267 mm	1267 mm	1267 mm	1267 mm	1267 mm	2067 mm
Width	600 mm	600 mm	600 mm	800 mm	1267 mm	800 mm	600 mm
Depth (over cladding)	860 mm	860 mm	1060 mm	860 mm	860 mm	1060 mm	860 mm
Weight of assembled rack	64 kg	73 kg	78 kg	73 kg	86 kg	88 kg	84 kg
Front door—Perforated	Single		Single	Single		Single	Single
Front door—Glass		Single			Single		
Rear door—Perforated	Single		Single	Split		Split	Single
Rear door—Solid metal		Single			Single		
Max rail mounting depth with cable tray removed	714 mm	714 mm	914 mm	714 mm	714 mm	914 mm	714 mm

Equipment mounting height	42U	42U	42U	42U	42U	42U	42U
Width & Depth (mm)	<b>600W x 800D</b>	<b>800W x 800D</b>	<b>600W x 1000D</b>	<b>600W x 1200D</b>	<b>800W x 800D</b>	<b>800W x 1000D</b>	<b>800W x 1200D</b>
Order Code (Black finish)	RAB42608PSB13U	RAB42808PSB13U	RAA42610PSB13U	RAA42612PSB13U	RAA42808PSB13U	RAA42810PSB13U	RAA42812PSB13U
<b>Physical</b>							
Height (castors fitted as standard)	2093 mm	2093 mm	2093 mm	2093 mm	2093 mm	2093 mm	2093 mm
Height (castors removed)	2067 mm	2067 mm	2067 mm	2067 mm	2067 mm	2067 mm	2067 mm
Width	600 mm	800 mm	600 mm	600 mm	800 mm	800 mm	800 mm
Depth (over cladding)	860 mm	860 mm	1060 mm	1260 mm	860 mm	1060 mm	1260 mm
Weight of assembled rack	92 kg	108 kg	98 kg	107 kg	95 kg	110 kg	120 kg
Front door—Perforated			Single	Single	Single	Single	Single
Front door—Glass	Single	Single					
Rear door—Perforated			Single	Single	Split	Split	Split
Rear door—Solid metal	Single	Single					
Max rail mounting depth with cable tray removed	714 mm	714 mm	914 mm	914 mm	714 mm	914 mm	1114 mm

Equipment mounting height	48U	48U	48U	48U	48U	48U	
Width & Depth (mm)	<b>600W x 800D</b>	<b>600W x 1000D</b>	<b>600W x 1200D</b>	<b>800W x 800D</b>	<b>800W x 1000D</b>	<b>800W x 1200D</b>	
Order Code (Black finish)	RAA48608PSB13U	RAA48610PSB13U	RAA48612PSB13U	RAA48808PSB13U	RAA48810PSB13U	RAA48812PSB13U	
<b>Physical</b>							
Height (castors fitted as standard)	2360 mm	2360 mm	2360 mm	2360 mm	2360 mm	2360 mm	
Height (castors removed)	2334 mm	2334 mm	2334 mm	2334 mm	2334 mm	2334 mm	
Width	600 mm	600 mm	600 mm	800 mm	800 mm	800 mm	
Depth (over cladding)	860 mm	1060 mm	1260 mm	860 mm	1060 mm	1260 mm	
Weight of assembled rack	91 kg	104 kg	114 kg	102 kg	118 kg	127 kg	
Front door—Perforated	Single	Single	Single	Single	Single	Single	
Front door—Glass							
Rear door—Perforated	Single	Single	Single	Split	Split	Split	
Rear door—Solid metal							
Max rail mounting depth with cable tray removed	714 mm	914 mm	1114 mm	714 mm	914 mm	1114 mm	



# Rack Horizontal Cable and Air Management

Eaton offers a range of accessories and retrofit-able upgrades which provide users with the opportunity to optimise the rack and room environment according to installation demands and budget constraints. Many of these accessories can be used on rack platforms from multiple vendors (denoted :Universal")

## In-Rack Horizontal Cable and Air Management

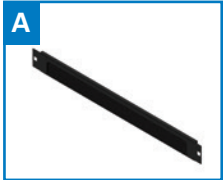

1U Cable Through 19-inch Panels.



2U Cable Through 19-inch Panels.



1U 19-inch Blanking Panels.



1U Horizontal Cable Managers.



2U Horizontal Cable Managers.



1U & 2U High Density Cable Managers.

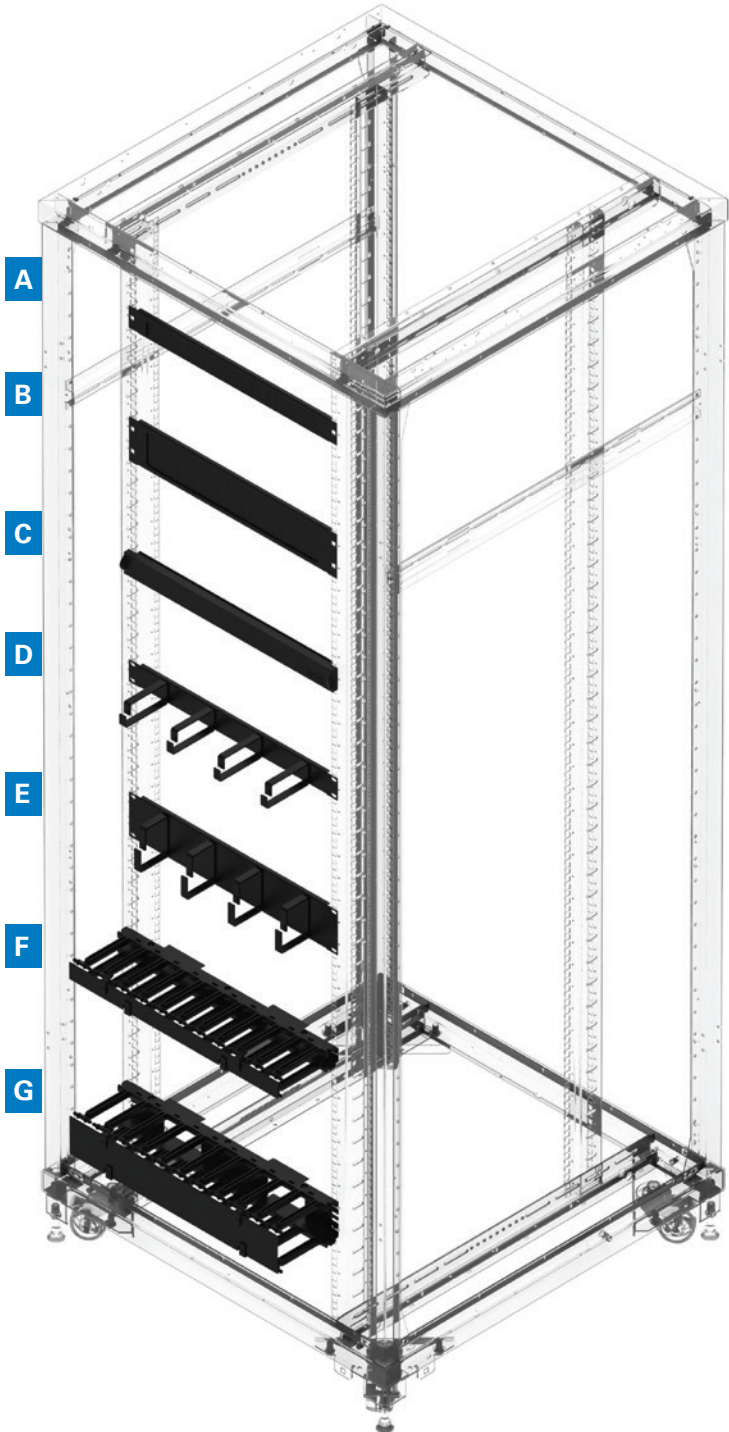

# Rack Horizontal Cable and Air Management

## Cable pass through 19-inch blanking panels

These open brush strip panels allow fitment without disturbing cable connections, and allow cables to be passed through the 19-inch aperture without compromising in-rack air management.



### Features / Benefits

- Universal mount to all square pierced EIA 310 compliant rails
- Open panel allows fitment with cabling in-situ
- Open feature with brush seal

### Compatibility

Part Code	Description	RA Series	Universal
ETN-OBSP1U	Blanking Panel 19" Cable Brush Strip 1U	•	•
ETN-OBSP2U	Blanking Panel 19" Cable Brush Strip 2U	•	•

## Clip-in tool-less 19-inch Blanking Panels

Designed to be used in any 19-inch compliant rack, these simple clip-in panels are quick and easy to deploy and simply snap into position without the need for any tools.

19-inch blanking panels help avoid the mixing and recirculation of air in the rack space.



### Features / Benefits

- Clip-in tool-less installation
- Universal 19-inch compliant
- Eaton branded

### Compatibility

Part Code	Description	RA Series	Universal
ETN-PBP1U10	19" Blanking Panel - Clip-on Plastic 1U (10pcs)	•	•

## 19-inch Horizontal Cable Managers

Available in 1U and 2U panel heights, these cable management panels are the industry default to the management of patch cabling. Configured with four rings per panel the 1U version is designed to manage 24 cables and the 2U version 48 cables.



### Features / Benefits

- Universal mount to EIA 310 compliant rails
- Open rings allow easy management of cables
- Cable ring depth: 70mm
- Finished black
- Supplied with cage nuts and screws for rack mounting

### Compatibility

Part Code	Description	RA Series	Universal
ETN-JRP1U	1U Horizontal Cable Manager (1pcs)	•	•
ETN-JRP2U	2U Horizontal Cable Manager (1pcs)	•	•

# Rack Horizontal Cable and Air Management

## High Density 19-inch Horizontal Cable Managers

Horizontal cable managers are available in heights of 1U & 2U. The depth of the unit allows for higher density cabling. Units allow cable transitions across the rack space, front to rear through the 19-inch aperture and above and below the managers to adjacent devices or patch panels..

### Features / Benefits

- Universal mount to EIA 310 compliant rails
- Promotes cable bend radius control
- Clip-on hinged covers hide cable tails
- Unit depth: 145mm
- Finished black



### Compatibility

Part Code	Description	Compatibility	
		RA Series	Universal
ETN-HDHCM1UBU	1U High Density Horizontal Cable Manager (1pcs)	•	•
ETN-HDHCM2UBU	2U High Density Horizontal Cable Manager (1pcs)	•	•

## Plastic Cable Rings

Available in two sizes these clip-locking plastic rings provide secure cable management capabilities in multiple locations. Each hoop can be screw-fixed into position using M6 screws.

ETN-CTSU external dimensions approx. 90mm x 55mm x 29mm

ETN-CTLU external dimensions approx. 127mm x 70mm x 29mm

### Features / Benefits

- Retro-fitable.
- Clip-locking provides secure cable management.
- Finish; Light grey.



### Compatibility

Part Code	Description	Compatibility	
		RA Series	Universal
ETN-CTSU	Cable Ring - Small Plastic, 1 pcs	•	•
ETN-CTLU	Cable Ring - Large Plastic, 1 pcs	•	•

## Velcro® Tie Wraps

These Velcro® tie wraps are ideal for safely bundling cables and securing to various structures on or inside a rack, these re-useable ties are ideal for use with cable trays, vertical cable channels, horizontal cable ring managers, high density horizontal cable managers as well as other applications.

### Features / Benefits

- Retro-fitable.
- Helps avoid damage to cables and promotes tidy cabling structures.
- Finish; Black.



### Compatibility

Part Code	Description	Compatibility	
		RA Series	Universal
ETN-BX45V11	Velcro tie wrap 280mm x 13mm (50 pcs)	•	•

# Rack Vertical Cable and Air Management

## Rack Vertical Cable Trays

These Cable Trays mount into the side of the RA Series racks. They provide the perfect securing method for cables, Rack PDUs and various accessories.

They are designed to mount to the front-to-rear frame members allowing them to be positioned to suit the application and space constraints. Standard RA Series racks include 2 x 100mm cable trays as a standard fitment within the rear of the rack.

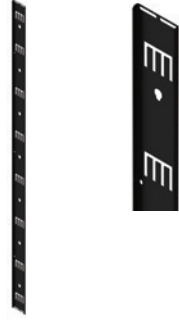

### Features / Benefits

- Enhanced, to allow easy and quick fitment of Rack PDU, cable ties, cage nuts and accessories
- Supplied with fixings and mounting instructions.
- Finish; Black

### Compatibility

Part Code	Description	Compatibility	
		RA Series	Universal
RA42CTK100S	RA 100mm Wide Cable Tray Kit 42U -BLK (1pcs)	•	n/a
RA48CTK100S	RA 100mm Wide Cable Tray Kit 48U -BLK (1pcs)	•	n/a

## Rack High Density Vertical Cable Manager

Supplied in single units, these high density vertical cable managers are designed to be mounted inside 800mm width racks. These managers are supplied with RCM fingers, dual hinged covers and incorporate cable-through features in the rear of the unit.



### Features / Benefits

- Retro-fitable.
- High-density cable management with RCM fingers and dual-hinged split covers.
- Supplied with fixings and mounting instructions.
- Finish; Black

### Compatibility

Part Code	Description	Compatibility	
		RA Series	Universal
RAHDVCMK42USU	RA High-Density Vertical Cable Manager Kit 42U - BLK (1pcs)	•	n/a
RAHDVCMK48USU	RA High-Density Vertical Cable Manager Kit 48U - BLK (1pcs)	•	n/a

# In Rack Vertical Cable and Air Management

## 600mm Wide Air management Baffle Kits

These baffle kits are designed to seal the gaps between the 19-inch rails and the rack frame side panels, and the gap at the top and bottom of the rack. Baffle kits coupled with 19-inch blanking panels provide in-rack air management and help avoid the mixing of supply and exhaust air to improve efficiency and reduce operating costs.

### Features / Benefits

- Retrofit-able.
- Easy to install.
- Promotes optimal air flow through the rack space.
- Helps lower operational costs and facilitates higher equipment densities.



### Compatibility

Part Code	Description	Compatibility	
		RA Series	Universal
RABK426SU	RA Series Baffle Kit - 42U x 600W - BLK	•	n/a
RABK486SU	RA Series Baffle Kit - 48U x 600W - BLK	•	n/a

## 800mm Wide Air management Baffle Kits

Like the 600mm wide baffle kits, these baffle kits are designed to seal the gaps between the 19-inch rails and the rack frame side panels, and the gap at the top and bottom of the rack. Baffle kits coupled with 19-inch blanking panels provide in-rack air management and help avoid the mixing of supply and exhaust air to improve efficiency and reduce operating costs.

### Features / Benefits

- Retrofit-able.
- Easy to install.
- Promotes optimal air flow through the rack space.
- Helps lower operational costs and facilitates higher equipment densities. Finish; Black



### Compatibility

Part Code	Description	Compatibility	
		RA Series	Universal
RABK428SU	RA Series Baffle Kit - 42U x 800W - BLK	•	n/a
RABK488SU	RA Series Baffle Kit - 48U x 800W - BLK	•	n/a

# Rack Shelving

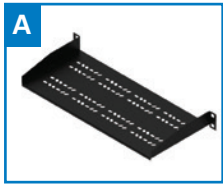

1U & 2U 19-inch mounted cantilever shelves.

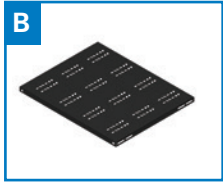

Standard duty & heavy duty 19-inch mounted fixed shelves.

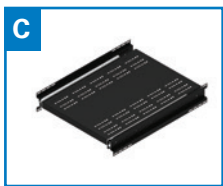

Standard duty 19-inch mounted sliding shelves-adjustable mounting depth.

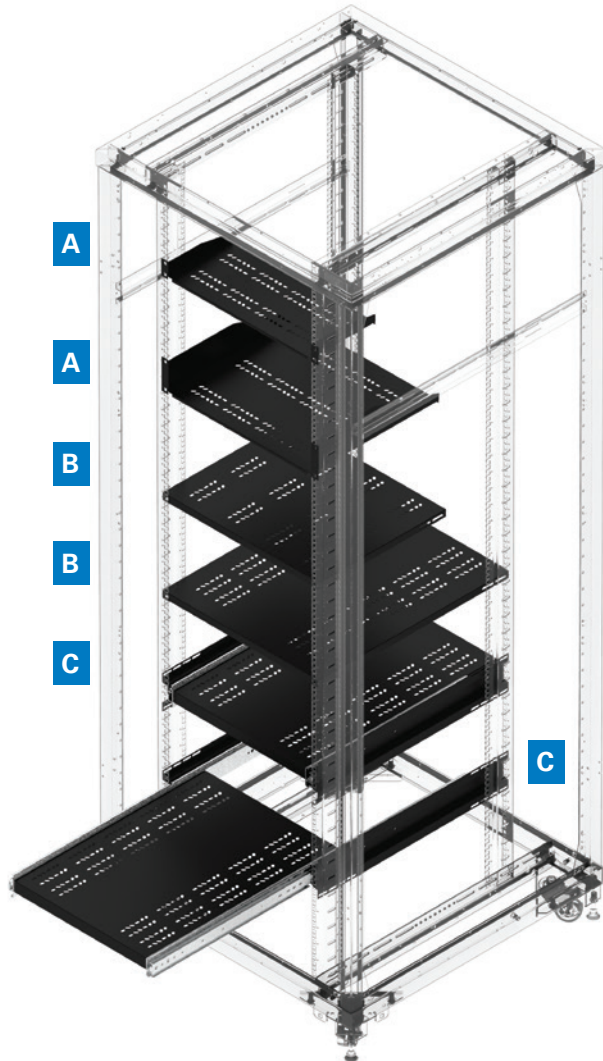

Order Code	Description	Rail Depth mm		
		Load Rating	Min Depth	Max Depth
ETN-MS20BU	1U x 200mm Deep Cantilever Shelf	15 kg	200	n/a
ETN-MS40BU	2U x 400mm Deep Cantilever Shelf	15 kg	400	n/a
ETN-SDFS1U40BU	1U Std Duty Fixed Shelf 400mm Deep	50 kg	400	400
ETN-HDFS1U60BU	1U Heavy Duty Fixed Shelf 600mm Deep	100 kg	600	600
ETN-LDATSV40BU	1U Standard Duty Sliding Shelf 400mm Deep	45 kg	404	749
ETN-LDATSV60BU	1U Standard Duty Sliding Shelf 600mm Deep	45 kg	444	812
ETN-LDATSV70BU	1U Standard Duty Sliding Shelf 700mm Deep	45 kg	444	940

# Rack Shelving

## Cantilever Shelves

These shelves are designed to mount to any EIA 310 compliant 19-inch rack. They can be used to support non rack mounted IT components such as monitors and modems. Perforated mounting surface provides tie-down points.

### Features / Benefits

- Universal mount to EIA 310 compliant rails.
- Load capacity 15kg evenly distributed (2 point mounting).
- Supplied with fixings and mounting instructions.
- Finish; Black.

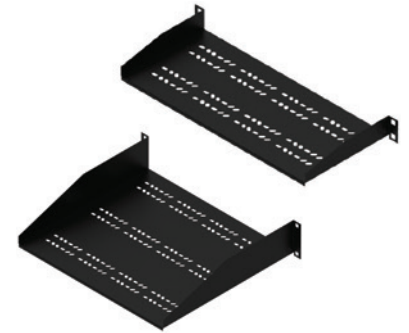

Compatibility

Part Code	Description	RA Series	Universal
ETN-MS20BU	Shelf - 19" Cantilever 1U x 200mm Deep	•	•
ETN-MS40BU	Shelf - 19" Cantilever 2U x 400mm Deep	•	•

## Standard Duty Fixed Shelves

These shelves are designed to mount into any EIA 310 compliant 19-inch rack. They can be used to support non rack mounted IT components such as monitors and modems . Perforated mounting surface provides tie down points.

### Features / Benefits

- Universal mount to EIA 310 compliant rails.
- Load capacity 50kg evenly distributed (4 point mounting).
- Supplied with fixings and mounting instructions.
- Finish; Black

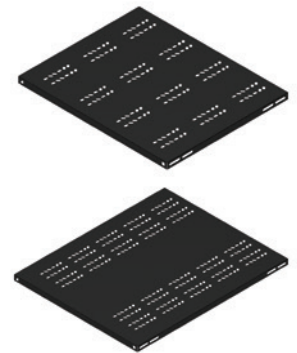

Compatibility

Part Code	Description	RA Series	Universal
ETN-SDFS1U40BU	Shelf - 19" Std Duty Fixed 1U x 400D	•	•

## Heavy Duty Fixed Shelves

These shelves are designed to mount into any EIA 310 compliant 19-inch rack. They can be used to support non rack mounted IT components such as monitors and modems . Perforated mounting surface provides tie down points.

### Features / Benefits

- Universal mount to EIA 310 compliant rails.
- Load capacity 100kg evenly distributed (4 point mounting).
- Usable depth 600mm
- Finish; Black

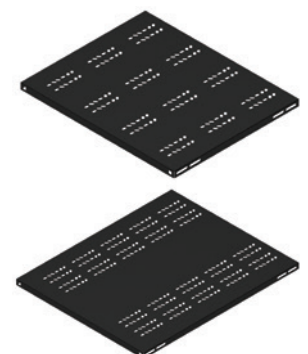

Compatibility

Part Code	Description	RA Series	Universal
ETN-HDFS1U60BU	Shelf - 19" Heavy Duty Fixed 1U x 600D	•	•

# Rack Shelving

## Standard Duty sliding shelves

These sliding shelves are designed to mount into any EIA 310 compliant 19-inch rack. They can be used to support non rack mounted IT components such as monitors and modems. Perforated mounting surface provides tie down points.

### Features / Benefits

- Universal mount to EIA 310 compliant rails.
- Load capacity 45kg evenly distributed (4 point mounting).
- Supplied with fixings and mounting instructions.
- Finish; Black.



### Compatibility

Part Code	Description	RA Series	Universal
ETN-LDATSV40BU	Shelf - 19" Standard Duty sliding 1U x 400mm Deep	•	•
ETN-LDATSV60BU	Shelf - 19" Standard Duty sliding 1U x 600mm Deep	•	•
ETN-LDATSV70BU	Shelf - 19" Standard Duty sliding 1U x 700mm Deep	•	•



# External Rack Upgrades

## Door Locking Upgrade Kit (Combination lock)

These upgrade kits allows users to upgrade the door locking option from a key locking swing handle to a mechanical 3-digit combination lock with key-override facility. The kits comprises a pair of combination handles supplied complete with fitting and user instructions to upgrade a single rack unit. Please note, there is 1 kit for single locking doors, and a different kit for double doors.

### Features / Benefits

- Allows separate codes to be set for different rack locations or groups of racks.
- Completely retrofit-able.
- Supplied with fitting and user instructions. Finish; Black.



### Compatibility

Part Code	Description	Compatibility	
		RA Series	Universal
RACLUK1	RA Combination Lock Upgrade Kit 1 point locking (suitable for single door)	•	n/a
RACLUK2	RA Combination Lock Upgrade Kit 2 point locking (suitable for split / double door)	•	n/a

## Door Locking Upgrade Kit (Proximity handles)

These upgrade kits allows users to upgrade the door locking option from a key locking swing handle to an electronic locking swing handle with inbuilt proximity card reader. The kits comprises a pair of handles and an access control unit and is supplied complete with fitting and user instructions to upgrade a single rack unit.

### Features / Benefits

- Integral key lock for manual over-ride, and LED status indicator.
- Completely retrofit-able.
- Supplied with fitting and user instructions.

### Compatibility

Part Code	Description	Compatibility	
		RA Series	Universal
RAPLUK	RA Proximity Locking Upgrade Kit - pair	•	n/a

## Plinth Kit

These plinth kits comprise a pair of side kick plates and front and rear kick plates. The kits mount to the base of the RA Series rack using cage nuts and screws. These plinth kits are designed to help close-off the gap between the rack and the floor. **Note; fitment only to racks with standard castors.**

### Features / Benefits

- Easily fitted and removed.
- Provides additional capacity for base entry incoming services.
- Supplied with fitting and user instructions.

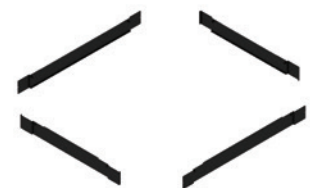

### Compatibility

Part Code	Description	Compatibility	
		RA Series	Universal
RAPK606BU	RA Plinth Panel Kit 600W 600D - BLK	•	n/a
RAPK608BU	RA Plinth Panel Kit 600W 800D - BLK	•	n/a
RAPK610BU	RA Plinth Panel Kit 600W 1000D - BLK	•	n/a
RAPK612BU	RA Plinth Panel Kit 600W 1200D - BLK	•	n/a
RAPK806BU	RA Plinth Panel Kit 800W 600D - BLK	•	n/a
RAPK808BU	RA Plinth Panel Kit 800W 800D - BLK	•	n/a
RAPK810BU	RA Plinth Panel Kit 800W 1000D - BLK	•	n/a
RAPK812BU	RA Plinth Panel Kit 800W 1200D - BLK	•	n/a

# Hardware & Accessories

## Fixing Kits

Fixing kits for installing equipment and accessories into the racks 19-inch rails.

### Features / Benefits

- Supplied bagged for on-site installation.



### Compatibility

Part Code	Description	Compatibility	
		RA Series	Universal
ETN-FPFPU	Fixings - Screw, Washer & cage M6 (50pcs)	•	•

## RA Series Earth Kit

Rack earth kits contain all the cable and fixings required to ground the rack components, providing earth continuity through the structure. These kits are supplied as standard in all standard RA Series racks, but can also be used to earth accessories such as rack shelves etc.



### Features / Benefits

- Supplied bagged for on-site installation.
- Supplied with fitting instructions.

### Compatibility

Part Code	Description	Compatibility	
		RA Series	Universal
RAEK	RA Series Earth Kit	•	n/a

## Universal Rack earth Bar kits

Eaton's 19-inch mounted earth bar kits can be fitted in any EIA 310 compliant rack. The universal kit takes up 1U of equipment space and can easily be positioned in any available slot. Importantly our design ensures that the earth bar is isolated from the rack allowing the building clean earth to be directly connected. Connecting the equipment mounted in the rack to the earth bar ensures continuity and optimal operation of the infrastructure, particularly important with higher performance cabling systems.

The vertically mounted kits also operate in the same principal, and can be fitted in all racks where vertical space allows.

### Features / Benefits

- Universal mount to all EIA 310 compliant rails.
- Multiple earth points.
- Supplied with all applicable fixings for square-pierced 19-inch rails.



Vertical Earth Bar Assembly



19-Inch Earth Bar Assembly

### Compatibility

Part Code	Description	Compatibility	
		RA Series	Universal
ETN-U19EBKU	Universal Rack 19" Earth Bar Kit (1pcs)	•	•
ETN-13EBKU	RA Series Earth Bar Kit 1334mm (1pcs)	•	•
ETN-18EBKU	RA Series Earth Bar Kit 1870mm (1pcs)	•	•

# Hardware & Accessories

## Rack PDU Mounting Brackets

Designed to mount to the vertical stiles of the RA Series rack, these Rack PDU mounting brackets allow Eaton's range of Rack PDUs to be optimally positioned in the rack space utilizing the Rack PDUs quick-mount bobbins. Each mounting kit can accommodate two vertically mounted Rack PDUs.



### Features / Benefits

- Accommodates 2 vertically-mounted Rack PDUs.
- Supplied with fitting and user instructions.
- Finish; Black.

### Compatibility

Part Code	Description	Compatibility	
		RA Series	Universal
RAEPDUMK	RA Rack PDU Mounting Kit (pair)	•	n/a

## Bolt-Together Kit

Each RA Series rack is configured with holes in the rack frame verticals allowing rows of same height racks to be bolted together for optimised stability and thermal efficiency. Racks of differing depths can also be bolted together with racks levelled along the front of the row. These kits are supplied as standard in all standard RA Series racks.



### Features / Benefits

- Simple kit for easy on-site installation.
- Supplied with fitting and user instructions.

### Compatibility

Part Code	Description	Compatibility	
		RA Series	Universal
RABTK	RA Series Baying Kit (1pcs)	•	n/a

Eaton is dedicated to ensuring that reliable, efficient and safe power is available when it's needed most. With unparalleled knowledge of electrical power management across industries, experts at Eaton deliver customised, integrated solutions to solve our customers' most critical challenges.

Our focus is on delivering the right solution for the application. But, decision makers demand more than just innovative products. They turn to Eaton for an unwavering commitment to personal support that makes customer success a top priority.

For more information, visit [www.eaton.eu/electrical](http://www.eaton.eu/electrical)

**Eaton**  
EMEA Headquarters  
Route de la Longeraie 7  
1110 Morges, Switzerland  
Eaton.eu

© 2019 Eaton  
All Rights Reserved  
Printed in Europe  
Publication No. BR159016EN  
July 2019

Eaton is a registered trademark.

All other trademarks are property  
of their respective owners.



*Powering Business Worldwide*